

# FALCON 5G MGA6331

## Fixed Wireless Access Gateway

### Quick Start Guide



© 2026 Vantiva. All rights reserved. All trade names referenced are service marks, trademarks or registered trademarks of their respective companies. Specifications subject to change without notice.

<b>MGA6331HTG Technical Specifications</b>	
Operating Voltage	200-240VAC ~50/60Hz
Weight	705g
Dimensions (W x D x H)	203.5 x 120 x 80mm
Operating Temperature Range	0°C to 40°C
Storage Temperature Range	-40°C to +70°C
External Power Supply Output Voltage/Current	12VDC/2A
Wireless connections	Wi-Fi 2.4GHz Access Point Wi-Fi 5GHz Access Point with TPC feature Cellular LTE (4G) Cellular 5G

# Front Panel

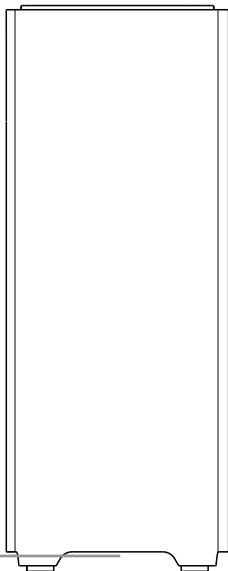

Status  
Indicator

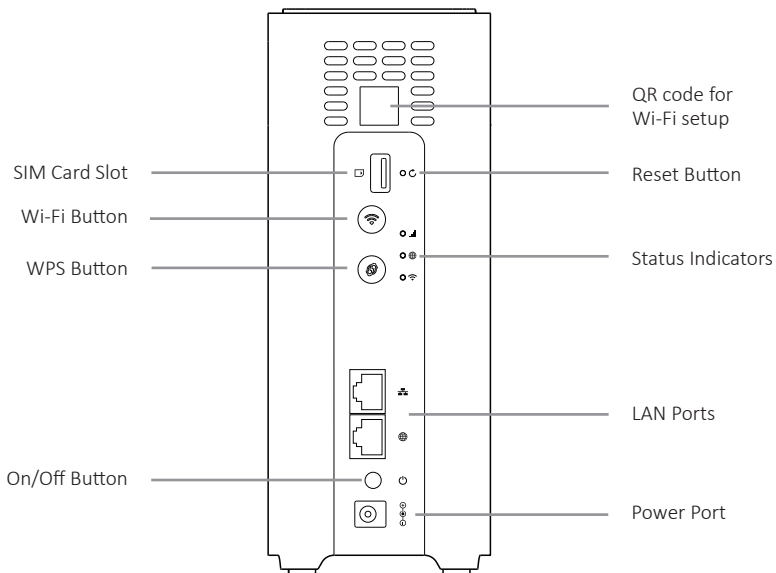

Indicator	Status	Description
Front Panel Status Indicator	Off	Powered off
	White	Powered on, booting up
	Flashing White	Firmware is being updated
	Flashing Green	Finished booting up and trying to connect, or connection lost and trying to reconnect
	Blue	Mobile connected
	Red	Mobile connection failed and retrying to connect
	Cycle all colors	Factory reset ongoing

# Rear Panel



Indicator	Status	Description
 WAN	Off	Not connected to mobile network
	Blue	Connected to mobile network
 5G/4G	Off	Not connected to mobile network
	Red	No mobile signal
	Orange	Poor mobile signal
	Green	Connected to 4G network
	Blue	Connected to 5G network
 Wi-Fi	Off	Wi-Fi disabled
	Blue	Wi-Fi enabled
	Very slow flashing blue	Wi-Fi initialization ongoing
	Flashing Blue	WPS pairing mode
	Slow flashing Blue	WPS paired
	Fast flashing Blue	WPS failed

# Setup

## A Before you begin:

- Find a location on the highest floor of your home, near a window with a clear, unobstructed view of the outdoors.
- Review the Important Safety Instructions included in the box.
- Ensure your 5G gateway is unplugged from the power outlet.



## B Insert SIM and power up:

1. Insert your nano-SIM into the SIM card slot until it clicks into place.
2. Connect the power adapter to your 5G gateway and plug it into a power outlet.
3. Wait a few minutes for the front panel indicator to turn to a steady color. If it turns red, move to another location near a window with a clear outdoor view and try again.

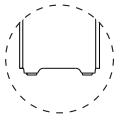
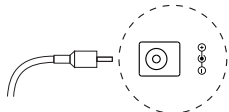
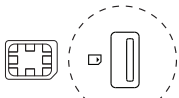

## C Connect your network devices:

- To set up a Wi-Fi connection, use your smartphone or tablet to scan the QR code on the rear of your 5G gateway and follow the on-screen instructions, or manually connect using the network name and password printed on the label at the base of your 5G gateway.

— or —

- For a wired connection, connect an Ethernet cable between your 5G gateway and your computer.

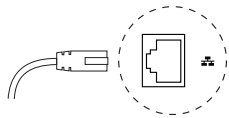

## D Advanced settings:

- Access the web interface by using the URL and default username/password provided on the label at the base of your 5G gateway.



6360649A